

0.43" Single Character DLO4135/DLG4137
0.68" Single Character DLO7135/DLG7137
5 x 7 Dot Matrix Intelligent Display® Devices with Memory/Decoder/Driver

**Lead (Pb) Free Product -
RoHS Compliant**

**SUPER-RED:
DLO4135, DLO7135**

**GREEN:
DLG4137, DLG7137**

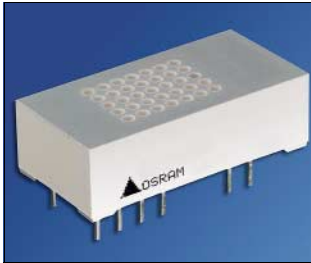

DLO4135 / DLG4137



DLO7135 / DLG7137

FEATURES

- 5 x 7 Dot Matrix Characters
DLO4135/DLG4137: 10.92 mm (0.43") High
DLO7135/DLG7137: 17.27 mm (0.68") High
- Wide Viewing Angle $\pm 75^\circ$
- 96 Character ASCII Set
Upper Case and Lower Case Characters
- Fully Encapsulated, Rugged Solid Plastic Package
- Built-in Memory
- Built-in Character Generator
- Built-in Multiplex and LED Drive Circuitry
- Built-in Lamp Test
- Intensity Control (4 levels)
- Microprocessor Bus Compatible
- Intensity Coded for Display Uniformity
- Single 5-Volt Power Supply
- X/Y Stackable
- Available in Super-red and Green

DESCRIPTION

The DLX413X/DLX713X are single digit 5 x 7 dot matrix Intelligent Display devices. The DLX413X character is 10.92 mm (0.43") high. The DLX713X character is 17.27 mm (0.68") high. The built-in CMOS integrated circuit contains memory, ASCII character generator, LED multiplexing and drive circuitry; thereby eliminating the need for additional circuitry. They will display the 96 ASCII characters.

These devices are TTL and microprocessor compatible and offer the possibility of cascading the displays, allowing for multi-character messages. These displays were designed for viewing distances of up to 20 feet (DLX413X) or 30 feet (DLX713X). They require a single 5-volt power supply and parallel ASCII input.

Important: Refer to Appnote 18, "Using and Handling Intelligent Display Devices" at www.osram-os.com. Since this is a CMOS device, normal precautions should be taken to avoid static damage.

Ordering Information

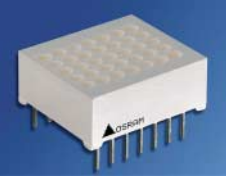
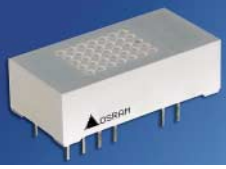
	Type	Color of Emission	Character Height mm (inch)	Ordering Code
	DLO7135	super-red	10.92 (0.68)	Q68000A7157
	DLG7137	green		Q68000A7159
	DLO4135	super-red	17.27 (0.43)	Q68000A4297
	DLO7135	green		Q68000A4299

Package Outlines

Dimensions in mm (inch)

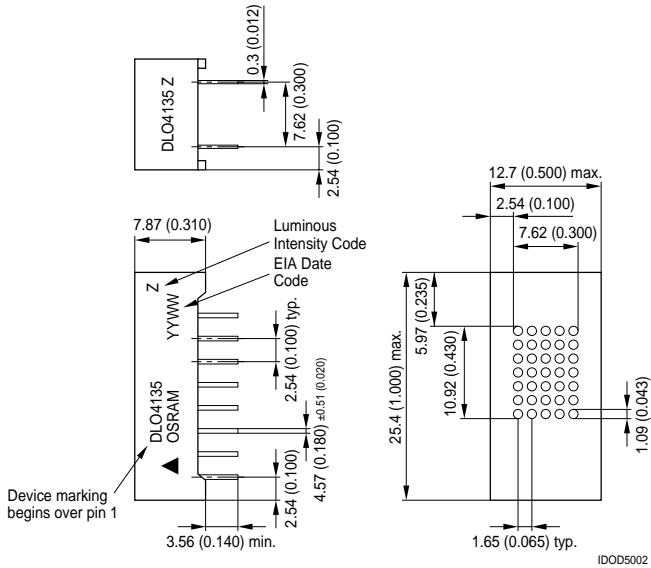

Package Outlines

Dimensions in mm (inch)

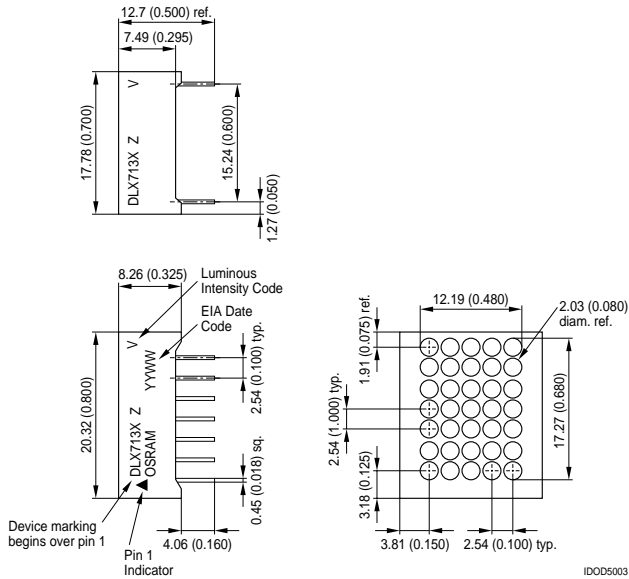

Maximum Ratings

Parameter	Symbol	Value	Unit
Operating temperature range ¹⁾	T_{op}	-40 to +85	°C
Storage temperature range	T_{stg}	-40 to +100	°C
V_{CC} range	V_{CC}	-0.5 to 7.0	Vdc
Voltage, Any Pin, Respect to GND		-0.5 to $V_{CC} + 0.5$	Vdc
Solder temperature 1.59 mm (0.063") below seating plane, $t < 5.0$ s	T_s	260	°C
Relative Humidity at 85°C (non condensing)		85	%

Optical Characteristics (typ.) $(T_A = 25\text{ °C})$

Parameter	Symbol	Values		Unit
		DLO4135 DLO7135	DLG4137 DLG7137	
		super-red	green	
Spectral Peak Wavelength (typ.)	λ_{peak}	635	565	nm
Viewing Angle	2ϕ	± 75	± 75	deg.
Time Averaged Luminous Intensity $V_{CC} = 5.0$ V (typ.)		1500	1500	mcd/Dot
Dot to Dot Intensity Ratio (max.)		1.8:1.0	1.8:1.0	

Luminous Intensity

DLO4135, DLG4137		DLO7135		DLG7137	
Bin	mcd per 5 dots	Bin	mcd per 5 dots	Bin	mcd per 5 dots
A	2.93 ... 3.62	A	3.6 ... 4.4	A	4.5 ... 5.5
B	3.63 ... 4.48	B	4.5 ... 5.4	B	5.6 ... 6.8
C	4.49 ... 5.55	C	5.5 ... 6.8	C	6.9 ... 8.5
D	5.56 ... 6.87	D	6.9 ... 8.4	D	8.6 ... 10.5
E	6.88 ... 8.50	E	8.5 ... 10.4	E	10.6 ... 13.0
F	8.51 ... 10.51	F	10.5 ... 12.9	F	13.1 ... 16.1
G	10.52 ... 13.00	G	13.0 ... 16.0	G	16.2 ... 20.0
H	13.01 ... 16.07	H	16.1 ... 18.4	H	20.1 ... 23.0
I	16.08 ... 19.87				
J	19.88 ... 24.56				
K	24.57 ... 30.35				
L	30.36 ... 37.51				

Conditions:

- $V_{CC} = 5.0$ Vdc
- Ambient Temperature = 25°C.
- 5 LEDs on at full brightness setting during measurement (Character Hex Code 2F).
- Accuracy of measurement is $\pm 11\%$.

Timing Parameters at 25°C ($V_{CC}=5.0\text{ V} \pm 0.5\text{ V}$)

Symbol	Parameter	Units (ns)
T_{CES}	Chip Enable Set-Up	10
T_{DS}	Data Set Up	100
T_W	Write Pulse	120
T_{DH}	Data Hold	20
T_{CEH}	Chip Enable Hold	20
T_{ACC}	Access Time	150

Timing Characteristics - Write Cycle Waveforms

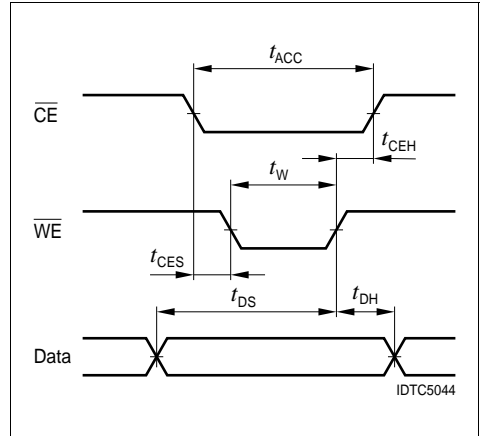

DC Characteristics

Parameter	-40°C			+25°C			+85°C			Units	Conditions
	Min.	Typ.	Max.	Min.	Typ.	Max.	Min.	Typ.	Max.		
I_{CC} (20 dots on)	—	135	—	—	100	140	—	85	—	mA	$V_{CC}=5.0\text{ V}$, $BL0=BL1=5.0\text{ V}$
I_{CC} Blank	—	2.0	—	—	1.5	4.0	—	0.8	—	mA	$V_{CC}=\overline{WR}=5.0\text{ V}$, $BL0=BL1=0\text{ V}$
I_{IL} (all inputs)	—	—	—	—	50	100	—	—	—	μA	$V_{IN}=0.8\text{ V}$, $V_{CC}=5.0\text{ V} \pm 0.5\text{ V}$
V_{IH}	2.0	—	—	2.0	—	—	2.0	—	—	V	$V_{CC}=5.0\text{ V} \pm 0.5\text{ V}$
V_{IL}	—	—	0.8	—	—	0.8	—	—	0.8	V	$V_{CC}=5.0\text{ V} \pm 0.5\text{ V}$
V_{CC}	4.5	5.0	5.5	4.5	5.0	5.5	4.5	5.0	5.5	V	—

Notes:

1. "Off Axis Viewing Angle" definition: The minimum angle in any direction from the normal to the display surface at which any part of any dot in the display is not visible.
2. This display contains a CMOS integrated circuit. Normal CMOS handling precautions should be taken to avoid damage due to high static voltages or electric fields. See Appnote 18 at www.osram-os.com under Intelligent Displays.
3. Unused inputs must be tied to an appropriate logic voltage level (either V+ or GND).
4. $V_{CC}=5.0\text{ Vdc} \pm 10\%$.
5. Clean only in water, isopropyl alcohol, TE (or equivalent).

Top View — DLO4135, DLG4137

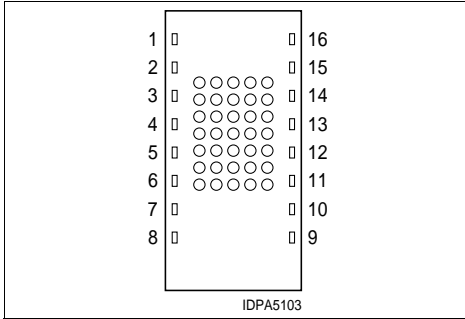

Pin Functions — DLO4135, DLG4137

Pin	Function	Pin	Function
1	$\overline{\text{LT}}$ Lamp	9	D0 Data LSB
2	$\overline{\text{WR}}$ Write	10	D1 Data
3	$\overline{\text{BL1}}$ Brightness	11	D2 Data
4	$\overline{\text{BL0}}$ Brightness	12	D3 Data
5	No Pin	13	D4 Data
6	No Pin	14	D5 Data
7	$\overline{\text{CE}}$ Chip Enable	15	D6 Data MSB
8	GND	16	+ V_{CC}

Top View — DLO7135, DLG7137

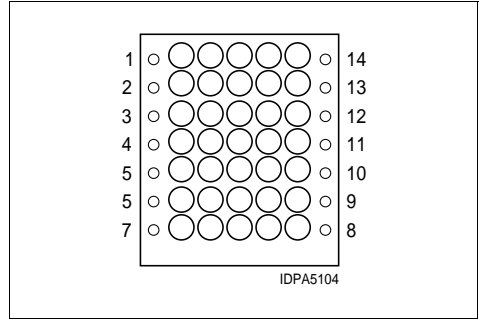

Pin Functions — DLO7135, DLG7137

Pin	Function	Pin	Function
1	V_{CC}	8	D0 Data Input LSB
2	$\overline{\text{LT}}$ Lamp Test	9	D1 Data
3	$\overline{\text{CE}}$ Chip Enable	10	D2 Data
4	$\overline{\text{WR}}$ Write	11	D3 Data
5	$\overline{\text{BL1}}$ Brightness	12	D4 Data
6	$\overline{\text{BL0}}$ Brightness	13	D5 Data
7	GND	14	D6 Data Input MSB

Lamp Test

When the lamp test (\overline{LT}) is activated, all dots on the display are illuminated at 1/7 brightness. The lamp test function is independent of write (\overline{WR}) and the settings of the blanking inputs ($\overline{BL0}$, $\overline{BL1}$). This convenient test gives a visual indication that all dots are functioning properly. Lamp test also may be used as a cursor function or pointer which does not destroy previously displayed characters.

Dimming and Blanking the Display

Brightness Level	$\overline{BL1}$	$\overline{BL0}$
Blank	0	0
1/7 Brightness	0	1
1/2 Brightness	1	0
Full Brightness	1	1

Loading Data

Loading data into the display is straightforward. Chip enable (\overline{CE}) should be present and stable during a write pulse (\overline{WR}). Parallel data information should be stable for the minimum time (T_w) and held for TDH after write has gone high. No synchronization is necessary and each character will continue to be displayed until it is replaced with another. Multiple displays may be stacked together with only an additional decoder IC for chip enable decoding.

Note:

Either $\overline{BL0}$ or $\overline{BL1}$ should be held high for display to light up.

Data Loading Example

\overline{CE}	\overline{WR}	$\overline{BL0}$	$\overline{BL1}$	\overline{LT}	Data Input							
					D6	D5	D4	D3	D2	D1	D0	
H	X	H	X	H	X	X	X	X	X	X	X	NC
X	X	L	L	H	X	X	X	X	X	X	X	Blank
X	X	X	X	L	X	X	X	X	X	X	X	Lamp Test
L	L	H	H	H	H	L	L	L	L	L	H	A
L	L	H	H	H	H	H	H	L	L	H	L	r
L	L	H	H	H	L	H	H	L	L	H	H	3
L	L	H	H	H	L	H	L	H	L	H	H	+

X=don't care, NC=no change

16 Digits Interconnection

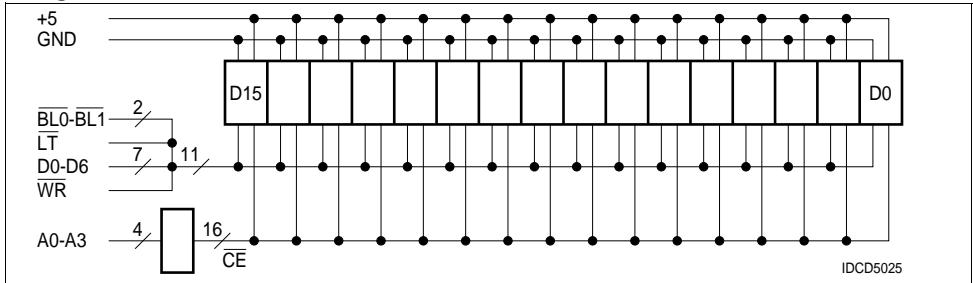

Character Set

ASC CODE	D0	0	1	0	1	0	1	0	1	0	1	0	1	0	1	0	1
	D1	0	0	1	1	0	0	1	1	0	0	1	1	0	0	1	1
	D2	0	0	0	0	1	1	1	1	0	0	0	0	1	1	1	1
	D3	0	0	0	0	0	0	0	0	1	1	1	1	1	1	1	1
D6 D5 D4	HEX	0	1	2	3	4	5	6	7	8	9	A	B	C	D	E	F
0 0 0 0	THESE CODES DISPLAY BLANK																
0 0 1 1	THESE CODES DISPLAY BLANK																
0 1 0 2	!	!	!	!	!	!	!	!	!	!	!	!	!	!	!	!	!
0 1 1 3	@	@	@	@	@	@	@	@	@	@	@	@	@	@	@	@	@
1 0 0 4	#	#	#	#	#	#	#	#	#	#	#	#	#	#	#	#	#
1 0 1 5	\$	\$	\$	\$	\$	\$	\$	\$	\$	\$	\$	\$	\$	\$	\$	\$	\$
1 1 0 6	%	%	%	%	%	%	%	%	%	%	%	%	%	%	%	%	%
1 1 1 7	&	&	&	&	&	&	&	&	&	&	&	&	&	&	&	&	&

IDCS5085

Notes:

1. High=1 level
2. Low=0 level
3. Upon power up, the device will initialize in a random state.

